

## SAE 45° Flared Fittings

### Advantages

This economical fitting resists mechanical pullout. Can be assembled and disassembled repeatedly. Manufactured from CA 360, CA 345 or CA 377 brass.

### Specifications

Listed with Underwriter's Laboratories for flammable liquid, marine, refrigeration and gas applications. Meets functional requirements of SAE J512 and J513, ASA, ASME and MS (Military Standards). Refer to list of UL listed fittings on page 6 for specific configurations.

### Applications

Use with copper, brass, aluminum and welded steel hydraulic tubing that can be flared. Manufactured especially for hard-to-hold liquids and gases.

### Working Pressure Ranges

Temperature and type of tubing used are important factors. However, the following table is a good guide for proper selection. Temperature 73°F with copper tubing:

PSI	TUBE O.D. (IN.)	TUBE WALL (IN.)
2800	1/8	.030
1900	3/16	.030
1400	1/4	.030
1200	5/16	.032
1000	3/8	.032
750	1/2	.032
650	5/8	.035
550	3/4	.035
450	7/8	.035

### Temperature Ranges

From -65° to +250°F.

### Vibration

Short nut may be used when vibration is minimal. The long nut offers additional vibration capacity.

### Assembly Instructions

1. Cut tubing squarely and clean tube end thoroughly to remove burrs.
2. Place nut onto tube. Place threaded end of nut toward end of tube.
3. Flare tube end with flaring tool to provide 45° flare.
4. Clamp tube flare between nut and nose of fitting body by screwing nut on finger-tight. Tighten with a wrench an additional 1/4 turn for a metal-to-metal seal.

Flare fittings are easy to disassemble and may be reassembled repeatedly, for a leak-proof connection.

### Order

By part number and name. SAE 45° flared bodies and nuts are separate items. Both numbers must be indicated when ordered.

### Nomenclature

Part numbers are constructed from symbols that identify the style and size of the fitting. The first series of numbers and letters identifies the style and type fitting. The second series of numbers describes the size.

#### Example:

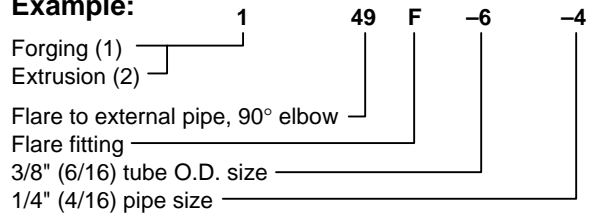

### Sizes

Tube sizes are determined by the numbers of sixteenths of an inch in the tube O.D.

### Special Fittings

Fitting configurations and/or sizes other than those shown in the catalog can be furnished. It is suggested that a print or sketch be submitted with the inquiry. Special UL stamped fittings are available. Please consult price list.

### Pricing

Only items priced in current supplementary price list PL3501 are carried in stock. Price and delivery for non-stock items furnished on request for specified quantity.

## SAE 45° Flared Fittings

### Refrigerant drum adapter 1F

Ref. SAE 010165

PART NO.	TUBE O.D.	PIPE THREAD	C HEX	L	FLOW DIA. D
1F-4-8	1/4	1/2	1-1/8	1.12	.187
1F-4-12	1/4	3/4	1-1/4	1.12	.187

Gasket Furnished with each 1F adapter

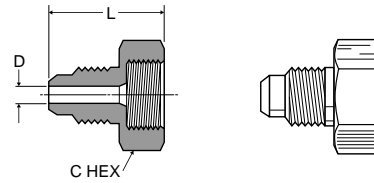

### Copper flare gasket 2GF

PART NO.	TUBE SIZE	A
2GF-3	3/16	.32
2GF-4	1/4	.37
2GF-5	5/16	.43
2GF-6	3/8	.56
2GF-8	1/2	.67
2GF-10	5/8	.78
2GF-12	3/4	.97

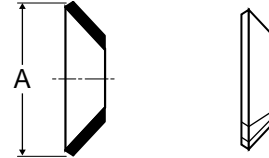

### Seal bonnet 3GF

PART NO.	TUBE SIZE	A
3GF-3	3/16	.32
3GF-4	1/4	.37
3GF-5	5/16	.43
3GF-6	3/8	.56
3GF-8	1/2	.67
3GF-10	5/8	.78
3GF-12	3/4	.97

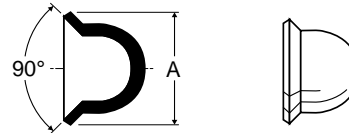

### Long forged nut 14FL

Ref. SAE 010167

PART NO.	TUBE SIZE	STRAIGHT THREAD	C HEX	D	L
14FL-4	1/4	7/16-20	5/8	.257	.94
14FL-6	3/8	5/8-18	13/16	.382	1.06
14FL-8	1/2	3/4-16	15/16	.507	1.19
14FL-10	5/8	7/8-14	1-1/16	.632	1.44

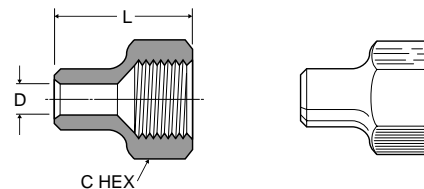

### Short forged nut 14FSX

PART NO.	TUBE SIZE	STRAIGHT THREAD	C HEX	D	L
14FSX-4	1/4	7/16-20	5/8	.257	.63
14FSX-5	5/16	1/2-20	11/16	.320	.67
14FSX-6	3/8	5/8-18	13/16	.382	.74
14FSX-8	1/2	3/4-16	15/16	.508	.86
14FSX-10	5/8	7/8-14	1-1/16	.632	.97
14FSX-12	3/4	1-1/16-14	1-5/16	.758	1.17

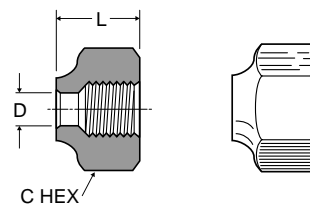

**Short forged reducing nuts 14FS**

PART NO.	TUBE SIZE	STRAIGHT THREAD	C HEX	D	L
14FS-6-4	3/8 to 1/4	5/8-18	13/16	.257	.74
14FS-8-6	1/2 to 3/8	3/4-16	15/16	.382	.86
14FS-10-8	5/8 to 1/2	7/8-14	1-1/16	.507	.99

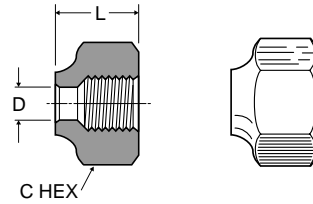

**Swivel nut valve connector 14FSV**

PART NO.	TUBE SIZE	STRAIGHT THREAD	C HEX	L
14FSV-4	1/4	7/16-20	5/8	1.31
14FSV-6	3/8	5/8-18	13/16	1.50
14FSV-8	1/2	3/4-16	15/16	1.75
14FSV-10	5/8	7/8-14	1-1/16	2.00

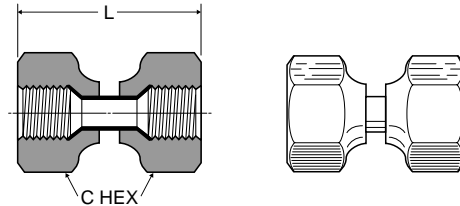

**Long nut 41FL**

Ref. SAE 010111

PART NO.	TUBE SIZE	STRAIGHT THREAD	C HEX	D	L
41FL-2	1/8	5/16-24	3/8	.133	.75
41FL-3	3/16	3/8-24	7/16	.195	.81
41FL-4	1/4	7/16-20	9/16	.257	.94
41FL-5	5/16	1/2-20	5/8	.320	1.12
41FL-6	3/8	5/8-18	3/4	.382	1.31
41FL-8	1/2	3/4-16	7/8	.507	1.62
41FL-10	5/8	7/8-14	1-1/16	.632	1.88
41FL-12	3/4	1-1/16-14	1-1/4	.758	2.19

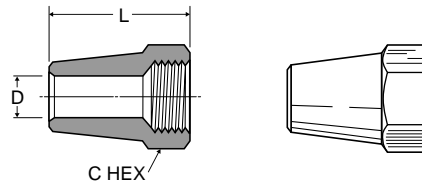

**Short nut 41FS / Shorter nut 41FX**

Ref. SAE 010110

PART NO.	TUBE SIZE	STRAIGHT THREAD	C HEX	D	L
41FS-2	1/8	5/16-24	3/8	.132	.50
41FS-3	3/16	3/8-24	7/16	.195	.62
41FS-4	1/4	7/16-20	9/16	.257	.75
41FS-5	5/16	1/2-20	5/8	.320	.88
41FS-6	3/8	5/8-18	3/4	.382	1.00
41FX-6	3/8	5/8-18	3/4	.382	.91
41FS-7	7/16	11/16-16	13/16	.445	1.06
41FS-8	1/2	3/4-16	7/8	.507	1.12
41FX-8	1/2	3/4-16	7/8	.507	1.00
41FS-10	5/8	7/8-14	1-1/16	.632	1.31
41FX-10	5/8	7/8-14	1-1/16	.632	1.06
41FS-12	3/4	1-1/16-14	1-1/4	.757	1.50
41FS-14	7/8	1-1/4-12	1-1/2	.882	1.62

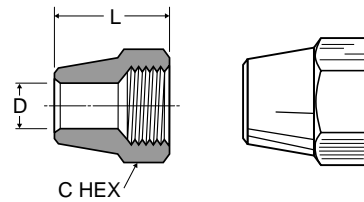

**Reducing nuts 41FS**

PART NO.	TUBE SIZE	STRAIGHT THREAD	C HEX	D	L
41FS-6-4	3/8 to 1/4	5/8-18	3/4	.257	1.00
41FS-8-6	1/2 to 3/8	3/4-16	7/8	.382	1.09
41FS-10-8	5/8 to 1/2	7/8-14	1-1/16	.507	1.25

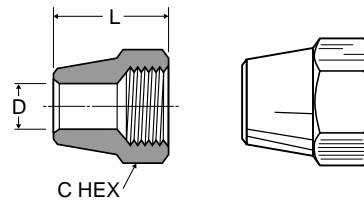

# SAE 45° Flared Fittings

## Union 42F

Ref. SAE 010101 \*Thread Protectors

PART NO.	TUBE SIZE	STRAIGHT THREAD	C HEX	L	D
42F-2	1/8	5/16-24	5/16	.90	.079
42F-3	3/16	3/8-24	3/8	1.04	.125
42F-4	1/4	7/16-20	7/16	1.17	.188
42F-5	5/16	1/2-20	1/2	1.32	.219
42F-6	3/8	5/8-18	5/8	1.48	.281
42F-8	1/2	3/4-16	3/4	1.79	.408
42F-10	5/8	7/8-14	7/8	2.10	.502
42F-12*	3/4	1-1/16-14	1-1/16	2.42	.626
42F-14*	7/8	1-1/4-12	1-1/4	2.72	.752

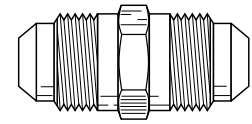
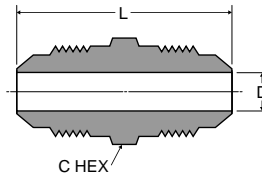

## Union reducers 42F

PART NO.	1 TUBE SIZE	2 TUBE SIZE	1 STRAIGHT THREAD	2 STRAIGHT THREAD	C HEX	L	FLOW DIA. D1	FLOW DIA. D2
42F-6-4	1/4	3/8	7/16-20	5/8-18	5/8	1.36	.281	.188
42F-6-5	5/16	3/8	1/2-20	5/8-18	5/8	1.42	.281	.219
42F-8-4	1/4	1/2	7/16-20	3/4-16	3/4	1.54	.408	.188
42F-8-6	3/8	1/2	5/8-18	3/4-16	3/4	1.67	.408	.281
42F-10-6	3/8	5/8	5/8-18	7/8-14	7/8	1.86	.502	.281
42F-10-8	1/2	5/8	3/4-16	7/8-14	7/8	1.98	.502	.408

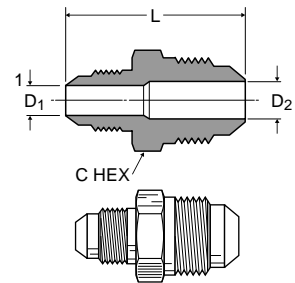

## Flare to Solder 43F

PART NO.	TUBE SIZE	SOLDER OD	STRAIGHT THREAD	C HEX	L	FLOW DIA. D
43F-4-4	1/4	1/4	7/16-20	7/16	.98	.189
43F-4-5	1/4	5/16	7/16-20	7/16	.98	.189
43F-4-6	1/4	3/8	7/16-20	1/2	.98	.189
43F-6-4	3/8	1/4	5/8-18	5/8	1.17	.189
43F-6-5	3/8	5/16	5/8-18	5/8	1.17	.252
43F-6-6	3/8	3/8	5/8-18	5/8	1.17	.283
43F-6-8	3/8	1/2	5/8-18	5/8	1.23	.283
43F-6-10	3/8	5/8	5/8-18	3/4	1.36	.283
43F-8-6	1/2	3/8	3/4-16	3/4	1.36	.314
43F-8-8	1/2	1/2	3/4-16	3/4	1.42	.408
43F-8-10	1/2	5/8	3/4-16	3/4	1.54	.408
43F-10-8	5/8	1/2	7/8-14	7/8	1.60	.440
43F-10-10	5/8	5/8	7/8-14	7/8	1.73	.502
43F-10-12	5/8	3/4	7/8-14	7/8	1.86	.502
43F-10-14	5/8	7/8	7/8-14	1	1.98	.502
43F-12-12	3/4	3/4	1-1/16-14	1-1/16	2.04	.627
43F-12-14	3/4	7/8	1-1/16-14	1-1/16	2.17	.627

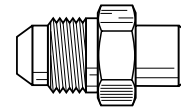
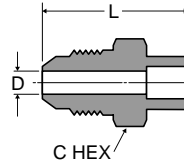

**Female connector 46F**

Ref. SAE 010103

PART NO.	TUBE SIZE	PIPE THREAD	STRAIGHT THREAD	C HEX	L	FLOW DIA. D
46F-2-2	1/8	1/8	5/16-24	9/16	.91	.078
46F-3-2	3/16	1/8	3/8-24	9/16	.95	.125
46F-4-2	1/4	1/8	7/16-20	9/16	1.01	.188
46F-4-4	1/4	1/4	7/16-20	11/16	1.23	.188
46F-4-6	1/4	3/8	7/16-20	13/16	1.26	.188
46F-5-2	5/16	1/8	1/2-20	9/16	1.05	.220
46F-5-4	5/16	1/4	1/2-20	11/16	1.26	.220
46F-6-2	3/8	1/8	5/8-18	5/8	1.10	.282
46F-6-4	3/8	1/4	5/8-18	11/16	1.29	.282
46F-6-6	3/8	3/8	5/8-18	13/16	1.36	.282
46F-6-8	3/8	1/2	5/8-18	1	1.60	.282
46F-8-4	1/2	1/4	3/4-16	3/4	1.39	.408
46F-8-6	1/2	3/8	3/4-16	13/16	1.48	.408
46F-8-8	1/2	1/2	3/4-16	1	1.73	.408
46F-8-12	1/2	3/4	3/4-16	1-5/32	1.65	.408
46F-10-6	5/8	3/8	7/8-14	7/8	1.57	.502
46F-10-8	5/8	1/2	7/8-14	1	1.80	.502
46F-10-12	5/8	3/4	7/8-14	1-5/32	1.75	.502

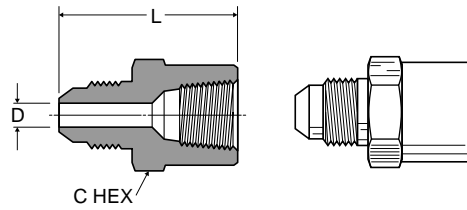

**Male connector 48F**

Ref. SAE 010102 \*Thread Protectors

PART NO.	TUBE SIZE	PIPE THREAD	STRAIGHT THREAD	C HEX	L	FLOW DIA. D
48F-2-2	1/8	1/8	5/16-24	7/16	.91	.078
48F-3-2	3/16	1/8	3/8-24	7/16	.98	.125
48F-3-4	3/16	1/4	3/8-24	9/16	1.17	.125
48F-4-2	1/4	1/8	7/16-20	7/16	1.04	.189
48F-4-4	1/4	1/4	7/16-20	9/16	1.23	.189
48F-4-6	1/4	3/8	7/16-20	11/16	1.29	.189
48F-4-8	1/4	1/2	7/16-20	7/8	1.54	.189
48F-5-2	5/16	1/8	1/2-20	1/2	1.14	.220
48F-5-4	5/16	1/4	1/2-20	9/16	1.32	.220
48F-5-6	5/16	3/8	1/2-20	11/16	1.36	.220
48F-6-2	3/8	1/8	5/8-18	5/8	1.23	.220
48F-6-4	3/8	1/4	5/8-18	5/8	1.42	.282
48F-6-6	3/8	3/8	5/8-18	11/16	1.42	.282
48F-6-8	3/8	1/2	5/8-18	7/8	1.67	.282
48F-6-12	3/8	3/4	5/8-18	1-1/16	1.79	.282
48F-8-4	1/2	1/4	3/4-16	3/4	1.60	.408
48F-8-6	1/2	3/8	3/4-16	3/4	1.60	.408
48F-8-8	1/2	1/2	3/4-16	7/8	1.79	.408
48F-8-12	1/2	3/4	3/4-16	1-1/16	1.92	.408
48F-10-4	5/8	1/4	7/8-14	7/8	1.79	.313
48F-10-6	5/8	3/8	7/8-14	7/8	1.79	.408
48F-10-8	5/8	1/2	7/8-14	7/8	1.98	.501
48F-10-12	5/8	3/4	7/8-14	1-1/16	2.04	.501
48F-12-8*	3/4	1/2	1-1/16-14	1-1/16	2.17	.562
48F-12-12*	3/4	3/4	1-1/16-14	1-1/16	2.17	.626
48F-14-12*	7/8	3/4	1-1/4-12	1-1/4	2.35	.752

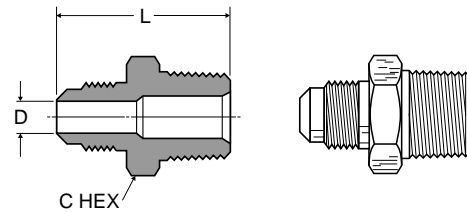

# SAE 45° Flared Fittings

## Union tee 144F-244F

Ref. SAE 010401

PART NO.	TUBE SIZE	STRAIGHT THREAD	L	M	FLOW DIA. D
144F-3	3/16	3/8-24	1.46	.73	.125
144F-4	1/4	7/16-20	1.72	.86	.189
244F-4	1/4	7/16-20	1.72	.86	.189
144F-5	5/16	1/2-20	1.82	.91	.220
144F-6	3/8	5/8-18	2.08	1.04	.283
144F-8	1/2	3/4-16	2.46	1.23	.408
144F-10	5/8	7/8-14	2.78	1.39	.503

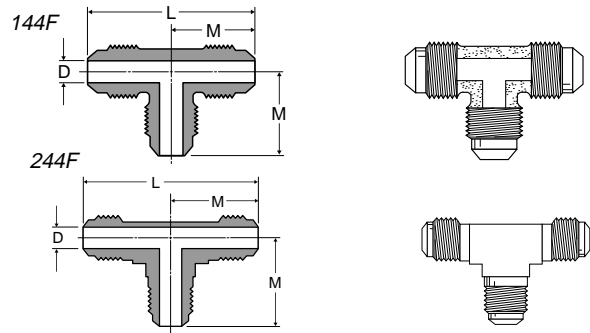

## Union tee 144F-244F combination sizes

PART NO.	1 TUBE SIZE	2 TUBE SIZE	3 TUBE SIZE	L	M	M1	FLOW DIA. D
144F-6-6-4	3/8	3/8	1/4	2.08	1.04	.89	.189
144F-8-8-6	1/2	1/2	3/8	2.40	1.20	1.10	.283

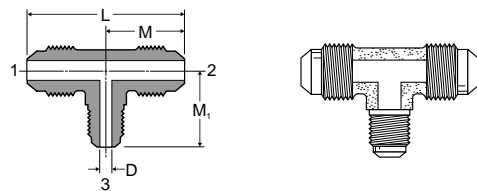

## Male branch tee 145F

Ref. SAE 010425

PART NO.	TUBE SIZE	PIPE THREAD	STRAIGHT THREAD	L	M	N	FLOW DIA. D
145F-2-2	1/8	1/8	5/16-24	1.26	.63	.69	.079
145F-4-2	1/4	1/8	7/16-20	1.58	.79	.76	.189
145F-4-4	1/4	1/4	7/16-20	1.78	.89	.92	.188
145F-5-4	5/16	1/4	1/2-20	1.90	.95	.96	.220
145F-6-4	3/8	1/4	5/8-18	1.96	.98	1.05	.281
145F-6-6	3/8	3/8	5/8-18	2.00	1.00	.98	.283
145F-6-8	3/8	1/2	5/8-18	2.28	1.14	1.26	.281
145F-8-6	1/2	3/8	3/4-16	2.40	1.20	1.10	.408
145F-8-8	1/2	1/2	3/4-16	2.46	1.23	1.36	.408
145F-10-8	5/8	1/2	7/8-14	2.78	1.39	1.36	.501

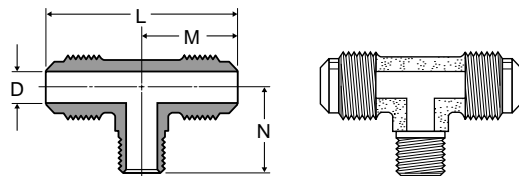

## Cross 147F

Ref. SAE 010501

PART NO.	TUBE SIZE	STRAIGHT THREAD	M	FLOW DIA. D
147F-6	3/8	5/8-18	1.04	.283

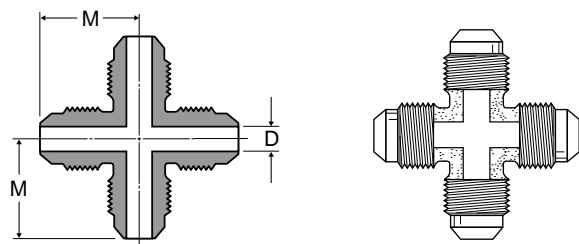

## Male elbow 149F-249F

Ref. SAE 010202 \*Thread Protectors

PART NO.	TUBE SIZE	PIPE THREAD	STRAIGHT THREAD	M	N	FLOW DIA. D
149F-2-2	1/8	1/8	5/16-24	.63	.73	.079
149F-3-2	3/16	1/8	3/8-24	.75	.75	.126
249F-3-2	3/16	1/8	3/8-24	.73	.73	.126
149F-4-2	1/4	1/8	7/16-20	.79	.76	.189
249F-4-2	1/4	1/8	7/16-20	.79	.76	.189
149F-4-4	1/4	1/4	7/16-20	.89	.92	.189
249F-4-4	1/4	1/4	7/16-20	.89	.92	.189
149F-4-6	1/4	3/8	7/16-20	.92	1.01	.189
249F-4-6	1/4	3/8	7/16-20	.92	1.01	.189

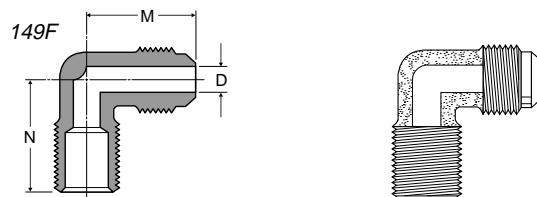

Continued next page

**Male elbow 149F-249F** *Continued from previous page*

Ref. SAE 010202 \*Thread Protectors

PART NO.	TUBE SIZE	PIPE THREAD	STRAIGHT THREAD	M	N	FLOW DIA. D
149F-5-2	5/16	1/8	1/2-20	.90	.79	.220
249F-5-2	5/16	1/8	1/2-20	.89	.77	.220
149F-5-4	5/16	1/4	1/2-20	.92	.95	.220
249F-5-4	5/16	1/4	1/2-20	.95	.92	.220
149F-5-6	5/16	3/8	1/2-20	.98	1.01	.219
149F-6-2	3/8	1/8	5/8-18	1.01	.90	.220
249F-6-2	3/8	1/8	5/8-18	1.01	.89	.220
149F-6-4	3/8	1/4	5/8-18	1.01	1.05	.283
249F-6-4	3/8	1/4	5/8-18	.98	1.04	.283
149F-6-6	3/8	3/8	5/8-18	1.04	1.07	.281
249F-6-6	3/8	3/8	5/8-18	1.04	1.07	.283
149F-6-8	3/8	1/2	5/8-18	1.15	1.27	.281
249F-6-8	3/8	1/2	5/8-18	1.14	1.26	.283
149F-6-12	3/8	3/4	5/8-18	1.25	1.38	.283
149F-8-4	1/2	1/4	3/4-16	1.20	1.17	.312
149F-8-6	1/2	3/8	3/4-16	1.20	1.09	.408
249F-8-6	1/2	3/8	3/4-16	1.20	1.10	.408
149F-8-8	1/2	1/2	3/4-16	1.28	1.38	.408
249F-8-8	1/2	1/2	3/4-16	1.26	1.36	.408
149F-8-12	1/2	3/4	3/4-16	1.38	1.38	.408
149F-10-6	5/8	3/8	7/8-14	1.41	1.25	.408
149F-10-8	5/8	1/2	7/8-14	1.39	1.36	.502
249F-10-8	5/8	1/2	7/8-14	1.39	1.36	.502
149F-10-12	5/8	3/4	7/8-14	1.42	1.48	.502
149F-12-8*	3/4	1/2	1-1/16-14	1.60	1.48	.564
149F-12-12*	3/4	3/4	1-1/16-14	1.59	1.62	.625
149F-14-12	7/8	3/4	1-1/4-12	1.73	1.67	.751

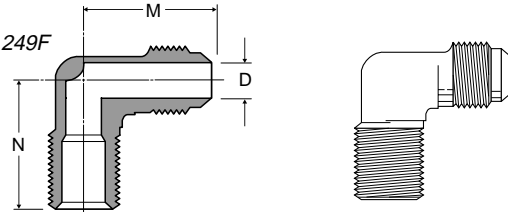
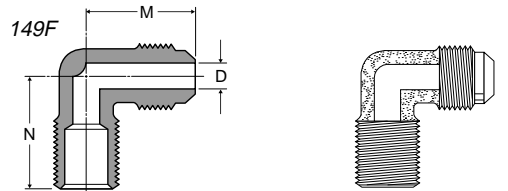

**Female elbow 150F**

Ref. SAE 010203

PART NO.	TUBE SIZE	PIPE THREAD	STRAIGHT THREAD	M	N	FLOW DIA. D	TYPE
150F-4-2	1/4	1/8	7/16-20	.86	.50	.189	A
150F-4-4	1/4	1/4	7/16-20	.95	.64	.189	A
150F-5-4	5/16	1/4	1/2-20	1.01	.64	.220	A
150F-6-2	3/8	1/8	5/8-18	1.08	.48	.283	B
150F-6-4	3/8	1/4	5/8-18	1.07	.67	.283	A
150F-6-6	3/8	3/8	5/8-18	1.14	.67	.283	A
150F-6-8	3/8	1/2	5/8-18	1.23	.86	.283	A
150F-8-6	1/2	3/8	3/4-16	1.25	.69	.408	A
150F-8-8	1/2	1/2	3/4-16	1.36	.94	.408	A
150F-8-12	1/2	3/4	3/4-16	1.41	.94	.408	A
150F-10-8	5/8	1/2	7/8-14	1.48	1.01	.502	A
150F-10-12	5/8	3/4	7/8-14	1.64	.98	.502	A

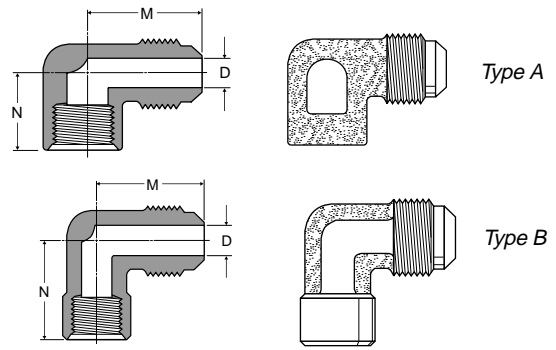

**Male run tee 151F**

Ref. SAE 010424

PART NO.	TUBE SIZE	PIPE THREAD	STRAIGHT THREAD	M	N	FLOW DIA. D
151F-4-2	1/4	1/8	7/16-20	.86	.76	.189
151F-4-4	1/4	1/4	7/16-20	.92	.89	.189
151F-5-4	5/16	1/4	1/2-20	.92	.95	.220
151F-6-4	3/8	1/4	5/8-18	1.04	1.04	.283
151F-6-6	3/8	3/8	5/8-18	.98	1.00	.283
151F-6-8	3/8	1/2	5/8-18	1.26	1.16	.283
151F-8-6	1/2	3/8	3/4-16	1.20	1.10	.406
151F-8-8	1/2	1/2	3/4-16	1.35	1.23	.408
151F-10-8	5/8	1/2	7/8-14	1.36	1.39	.500

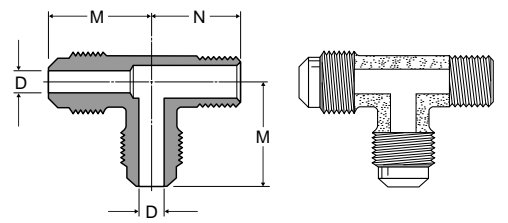

## SAE 45° Flared Fittings

### Union elbow 155F

Ref. SAE 010201 \*Thread Protectors

PART NO.	TUBE SIZE	STRAIGHT THREAD	M	FLOW DIA. D
155F-2	1/8	5/16-24	.64	.079
155F-3	3/16	3/8-24	.73	.126
155F-4	1/4	7/16-20	.86	.189
155F-5	5/16	1/2-20	.92	.220
155F-6	3/8	5/8-18	1.04	.283
155F-8	1/2	3/4-16	1.31	.408
155F-10	5/8	7/8-14	1.39	.502
155F-12*	3/4	1-1/16-14	1.63	.625

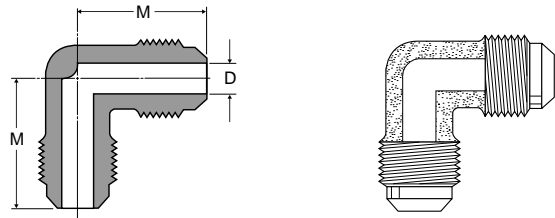

### 45° elbow 159F-259F

Ref. SAE 010302 \*Thread Protectors

PART NO.	TUBE SIZE	PIPE THREAD	STRAIGHT THREAD	M	N	FLOW DIA. D
159F-4-2	1/4	1/8	7/16-20	.78	.56	.188
259F-4-2	1/4	1/8	7/16-20	.65	.62	.188
159F-4-4	1/4	1/4	7/16-20	.75	.84	.188
259F-4-4	1/4	1/4	7/16-20	.73	.84	.188
159F-5-2	5/16	1/8	1/2-20	.75	.65	.220
159F-5-4	5/16	1/4	1/2-20	.75	.81	.220
159F-6-2	3/8	1/8	5/8-18	.89	.67	.220
159F-6-4	3/8	1/4	5/8-18	.89	.86	.283
259F-6-4	3/8	1/4	5/8-18	.91	.86	.283
159F-6-6	3/8	3/8	5/8-18	.91	.93	.283
259F-6-6	3/8	3/8	5/8-18	.91	.93	.283
159F-8-4	1/2	1/4	3/4-16	1.06	.95	.408
159F-8-6	1/2	3/8	3/4-16	1.06	.95	.408
259F-8-6	1/2	3/8	3/4-16	1.04	.93	.408
159F-8-8	1/2	1/2	3/4-16	1.00	.87	.406
259F-8-8	1/2	1/2	3/4-16	1.10	1.15	.408
159F-10-6	5/8	3/8	7/8-14	1.13	.95	.406
259F-10-6	5/8	3/8	7/8-14	1.20	1.15	.503
159F-10-8	5/8	1/2	7/8-14	1.21	1.16	.503
259F-10-8	5/8	1/2	7/8-14	1.21	.98	.503
159F-12-8*	3/4	1/2	1-1/16-14	1.28	1.16	.560

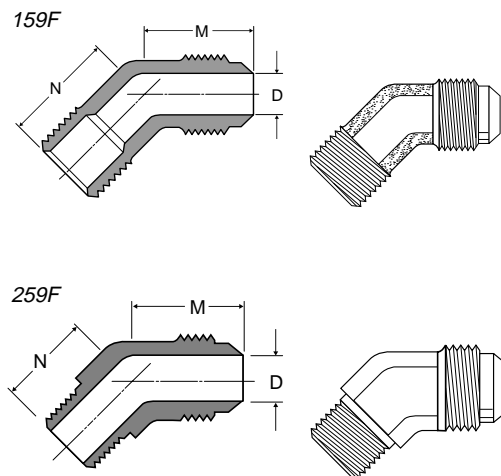

### 90° swivel elbow 166FSV

PART NO.	TUBE SIZE	STRAIGHT THREAD	C HEX	M	N	FLOW DIA. D
166FSV-4-4	1/4	7/16-20	5/8	.86	.93	.189
166FSV-6-6	3/8	5/8-18	13/16	1.04	1.12	.282
166FSV-8-8	1/2	3/4-16	15/16	1.23	1.31	.408
166FSV-10-10	5/8	7/8-14	1-1/16	1.39	1.50	.502
166FSV-12-12	3/4	1-1/16	1-5/16	1.60	1.79	.627

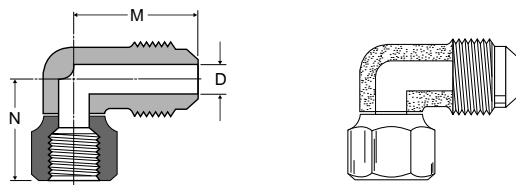

### Adapter tee 256F

PART NO.	TUBE SIZE	PIPE THREAD	STRAIGHT THREAD	M	N	N1	FLOW DIA. D
256F-4-2	1/4	1/8	7/16-20	.86	.76	.47	.188

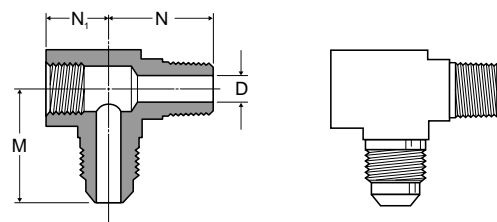

**Flared seal plug 639F**

PART NO.	TUBE SIZE	STRAIGHT THREAD	C HEX	L
639F-4	1/4	7/16-20	7/16	.69
639F-5	5/16	1/2-20	1/2	.78
639F-6	3/8	5/8-18	5/8	.88
639F-8	1/2	3/4-16	3/4	1.06
639F-10	5/8	7/8-14	7/8	1.19

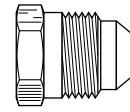
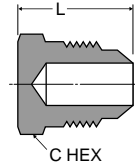

**Cap nut 640F**

PART NO.	TUBE SIZE	STRAIGHT THREAD	C HEX	L
640F-3*	3/16	3/8-24	1/2	.47
640F-4*	1/4	7/16-20	9/16	.53
640F-5*	5/16	1/2-20	5/8	.62
640F-6*	3/8	5/8-18	3/4	.58
640F-8*	1/2	3/4-16	7/8	.84
640F-10*	5/8	7/8-14	1-1/16	.97

\*Should be used with 2GF copper gasket.

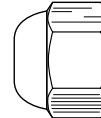
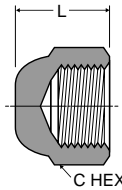

**Flared union—female flare to female flare 660FHD**

Ref. SAE 010107

PART NO.	TUBE SIZE	STRAIGHT THREAD	C HEX	L	FLOW DIA. D
660FHD-4*	1/4	7/16-20	5/8	1.03	.250
660FHD-6*	3/8	5/8-18	13/16	1.26	.375
660FHD-8*	1/2	3/4-16	15/16	1.43	.500
660FHD-10*	5/8	7/8-14	1-1/16	1.69	.626

\*Should be used with 2GF copper gasket.

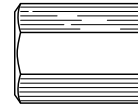
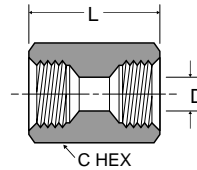

**Reducer—male flare to female flare 661FHD**

Ref. SAE 010105

PART NO.	1 TUBE SIZE	2 TUBE SIZE	1 STRAIGHT THREAD	2 STRAIGHT THREAD	C HEX	L	FLOW DIA. D
661FHD-4-6*	1/4	3/8	7/16-20	5/8-18	13/16	1.20	.189
661FHD-4-8*	1/4	1/2	7/16-20	3/4-16	15/16	1.36	.189
661FHD-6-4*	3/8	1/4	5/8-18	7/16-20	5/8	1.10	.283
661FHD-6-8*	3/8	1/2	5/8-18	3/4-16	15/16	1.42	.283
661FHD-8-6*	1/2	3/8	3/4-16	5/8-18	13/16	1.39	.377
661FHD-8-10*	1/2	5/8	3/4-16	7/8-14	1-1/16	1.67	.408
661FHD-10-8*	5/8	1/2	7/8-14	3/4-16	15/16	1.60	.502
661FHD-10-12*	5/8	3/4	7/8-14	1-1/16-14	1-5/16	1.95	.502
661FHD-12-10*	3/4	5/8	1-1/16-14	7/8-14	1-1/16	1.86	.626

\*Should be used with 2GF copper gasket.

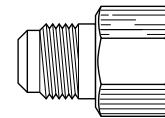
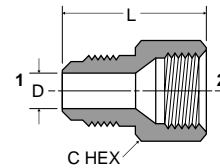

**Female flare to male pipe thread 664FHD**

Ref. SAE 010106

PART NO.	TUBE SIZE	PIPE THREAD	STRAIGHT THREAD	C HEX	L	FLOW DIA. D
664FHD-4-2*	1/4	1/8	7/16-20	5/8	.91	.219
664FHD-4-4*	1/4	1/4	7/16-20	5/8	1.01	.250
664FHD-6-4*	3/8	1/4	5/8-18	13/16	1.28	.344
664FHD-8-6*	1/2	3/8	3/4-16	15/16	1.36	.406

\*Should be used with 2GF copper flare gasket.

